

VAS22-S80E-2-RSC5.31T/TXL

– Extension Cable

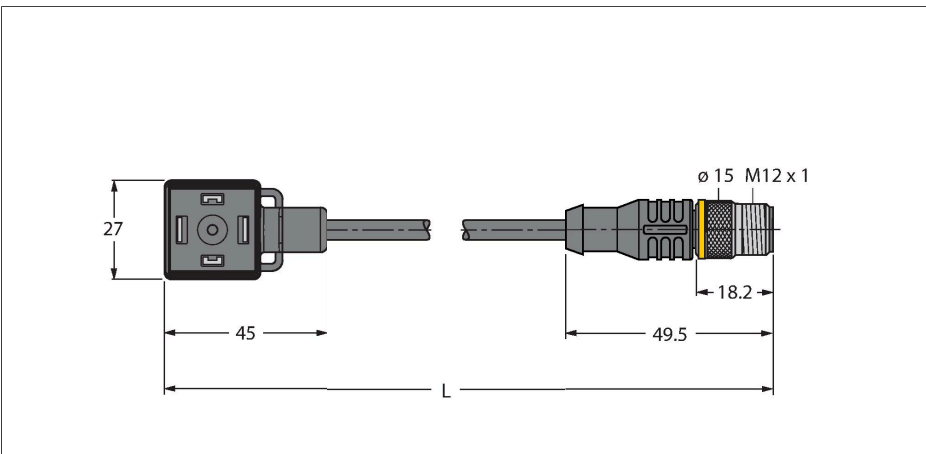

Features



- 2-pin + PE
- Design according to the DIN EN 175301-803
- RoHS-compliant
- Protection class: IP65, IP67, IP68
- Protective component: Transil diode
- M12 male, straight, 2-pin + PE
- Jacket material: PUR
- Jacket color: black
- Suitable for drag chain use
- Resistant to chemicals and oils
- UV and ozone resistance
- Flame retardant
- Free from halogen, silicone, PVC and LABS
- Cable length: 2.0 m

Technical data

Type	VAS22-S80E-2-RSC5.31T/TXL
ID	6606509
Number of Pins	2+PE, PE bridged
Protective component	Transil diode
Display switch state	LED, Yellow/Yellow
Protection class	IP65, IP67, IP68
Connector B	Male, M12 × 1, Straight
Number of pins	2+PE
Contacts	Metal, CuZn, Gold-plated
Contact carriers	Plastic, TPU, Black
Connector body	Plastic, TPU, Black
Coupling nut/retaining screw	Brass, CuZn, Nickel-plated
Tightening torque	0.8 ... 1 Nm
Mechanical life	> 100 Mating cycles
Pollution degree	3
Protection class	IP67, IP69K, Only when screwed together
Cable diameter	Ø 5.2 mm ±0.20
Cable length	2 m
Cable jacket	PUR, Black
Core insulation	PP
Core cross-section	3 x 0.75 mm ²
Arrangement of strands	42 x 0.1 mm
Core colors	BN, BU, GNYE
Electrical properties at +20 °C	
Test voltage	2000 V
Current	4 A
Insulation resistance	> 1 MΩ/km

Contact assignment

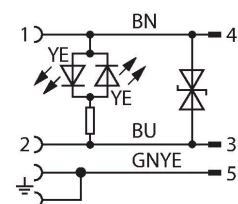
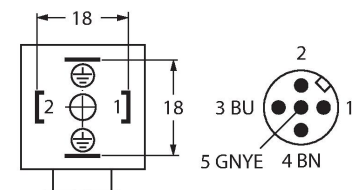

Technical data

forward resistance max. 57 Ω /km

Mechanical and chemical properties	
Max. tensile strength (static)	$\leq 50 \text{ N/mm}^2$
Max. tensile strength (dynamic)	$\leq 20 \text{ N/mm}^2$
Bending radius (stationary installation)	$\geq 5 \times \varnothing$
Bending radius (flexible use)	$\geq 10 \times \varnothing$
Bending cycles	≥ 3 million
Admissible acceleration	max. 5 m/s^2
Admissible travel path, horizontal	5 m (at 5 m/s^2)
Admissible travel path, vertical	2 m (at 5 m/s^2)
Admissible traversing speed	3.3 m/s
Torsional stress	$\pm 180^\circ/\text{m}$
Ambient temperature range (stationary)	$-40^\circ\text{C} \dots +80^\circ\text{C}$
Ambient temperature range (In motion)	$-30^\circ\text{C} \dots +90^\circ\text{C}$
Ambient temperature during drag chain operation	$-25^\circ\text{C} \dots +60^\circ\text{C}$
Approvals	CE UKCA