

VAS04-K81E-0.3-WSC5T/TXL

Valve connector A type

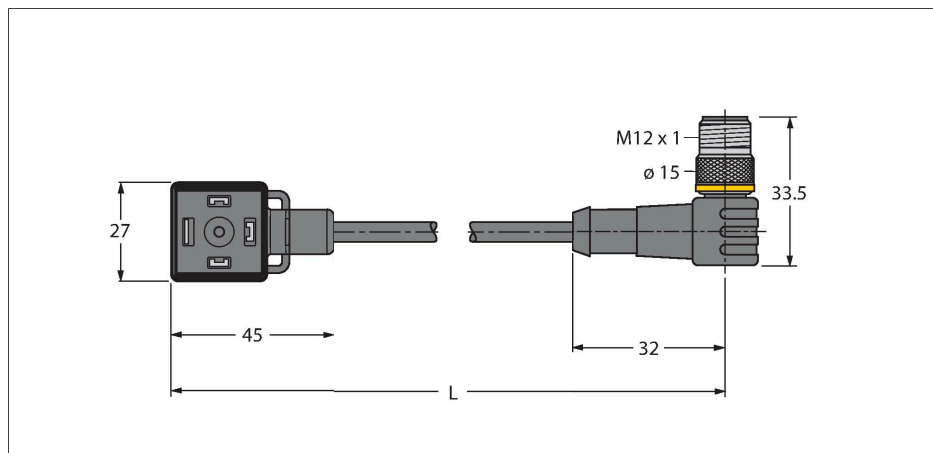

Features



- 3-pin + PE / strand connection
- Design according to the DIN EN 175301-803
- RoHS-compliant
- Protection class: IP65, IP67, IP68
- Without protective circuitry
- M12 male, angled, 4-pin + PE
- Jacket material: PUR
- Jacket color: black
- Suitable for drag chain use
- Resistant to chemicals and oils
- UV and ozone resistance
- Flame retardant
- Free from halogen, silicone, PVC and LABS
- Cable length: 0.3 m

Technical data

Type	VAS04-K81E-0.3-WSC5T/TXL
ID	6606798
Connector A	Valve connector, Design A
Number of Pins	3+PE
Contacts	Metal, CuSn, Silver-plated
Contact carriers	Plastic, PA, Black
Connector body	Plastic, TPU, Black/Translucent
Protective component	without protective circuitry
Seal	Plastic, TPU
Display switch state	LED, Yellow/Green
Mechanical lifespan	> 100 Mating cycles
Pollution degree	3
Protection class	IP65, IP67, IP68, (mounted)
Connector B	Male, Straight
Number of pins	4+PE
Cable diameter	Ø 5.2 mm ±0.20
Cable length	0.3 m
Cable jacket	PUR, Black
Core insulation	PP
Core cross-section	4 x 0.75 mm ²
Arrangement of strands	42 x 0.1 mm
Core colors	BN, WH, BU, BK, GNYE
Electrical properties at +20 °C	
Rated voltage	24 V
Test voltage	2000 V
Current	4 A
Insulation resistance	> 1 MΩ/km

Contact assignment

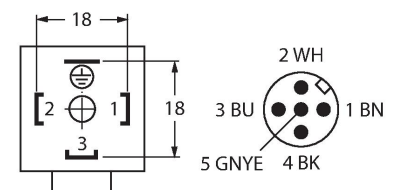

Circuit Diagram

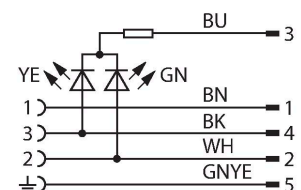

Technical data

Insulation resistance	$\geq 10^8 \Omega$
forward resistance	max. 57 Ω/km
Mechanical and chemical properties	
Max. tensile strength (static)	$\leq 50 \text{ N/mm}^2$
Max. tensile strength (dynamic)	$\leq 20 \text{ N/mm}^2$
Bending radius (stationary installation)	$\geq 5 \times \varnothing$
Bending radius (flexible use)	$\geq 10 \times \varnothing$
Bending cycles	≥ 3 million
Admissible acceleration	max. 5 m/s^2
Admissible travel path, horizontal	5 m (at 5 m/s^2)
Admissible travel path, vertical	2 m (at 5 m/s^2)
Admissible traversing speed	3.3 m/s
Torsional stress	$\pm 180^\circ/\text{m}$
Ambient temperature range (stationary)	-40 $^\circ\text{C}$...+80 $^\circ\text{C}$
Ambient temperature range (In motion)	-30 $^\circ\text{C}$...+90 $^\circ\text{C}$
Ambient temperature during drag chain operation	-25 $^\circ\text{C}$...+60 $^\circ\text{C}$
Mounting screw	Brass, CuZn, nickel-plated
Approvals	CE UKCA