

VC9S22-T80E-5-WSC5.31T/TXL

Valve connector CI type

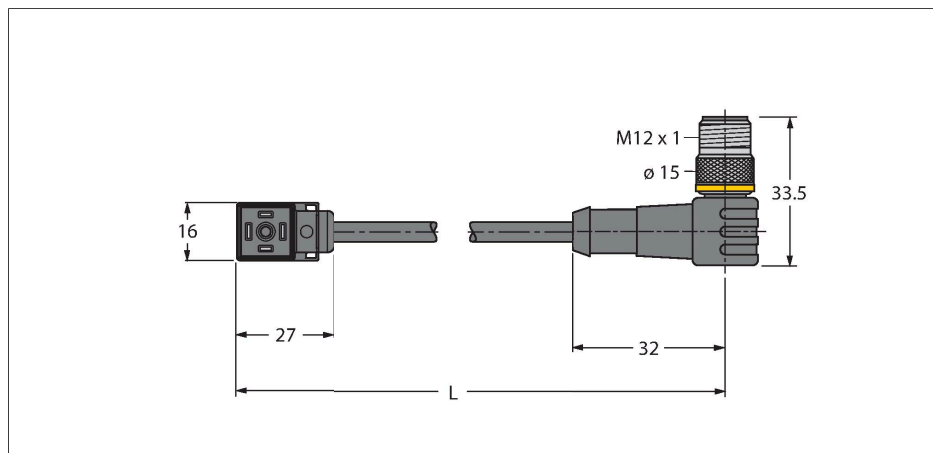

Features



- 2-pin + PE, bridged
- Design according to the DIN EN 175301-803
- RoHS-compliant
- Protection class: IP65, IP67, IP68
- Protective component: Z-diode
- M12 male, angled, 2-pin + PE
- Jacket material: PUR
- Jacket color: black
- Suitable for drag chain use
- Resistant to chemicals and oils
- UV and ozone resistance
- Flame retardant
- Free from halogen, silicone, PVC and LABS
- Cable length: 5.0 m

Technical data

Type	VC9S22-T80E-5-WSC5.31T/TXL
ID	6606920
Connector A	Valve connector, Design CI
Number of Pins	2+PE, PE bridged
Contacts	Metal, CuSn, Silver-plated
Contact carriers	Plastic, PA, Black
Connector body	Plastic, TPU, Black/Translucent
Protective component	Z diode
Seal	Plastic, TPU
Display switch state	LED, Yellow/Yellow
Mechanical lifespan	> 100 Mating cycles
Pollution degree	3
Protection class	IP65, IP67, IP68, (mounted)
Connector B	Male, Angled
Cable diameter	Ø 5.2 mm ±0.20
Cable length	5 m
Cable jacket	PUR, Black
Core insulation	PP
Core cross-section	3 x 0.75 mm ²
Arrangement of strands	42 x 0.1 mm
Core colors	BN, BU, GNYE
Electrical properties at +20 °C	
Rated voltage	24 V
Test voltage	2000 V
Current	4 A
Insulation resistance	> 1 MΩ/km
Insulation resistance	≥ 10 ⁸ Ω

Contact assignment



Circuit Diagram

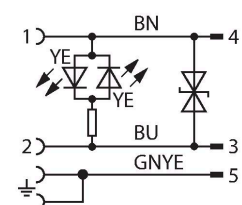

Technical data

forward resistance max. 57 Ω /km

Mechanical and chemical properties

Max. tensile strength (static) $\leq 50 \text{ N/mm}^2$

Max. tensile strength (dynamic) $\leq 20 \text{ N/mm}^2$

Bending radius (stationary installation) $\geq 5 \times \varnothing$

Bending radius (flexible use) $\geq 10 \times \varnothing$

Bending cycles ≥ 3 million

Admissible acceleration max. 5 m/s^2

Admissible travel path, horizontal 5 m (at 5 m/s^2)

Admissible travel path, vertical 2 m (at 5 m/s^2)

Admissible traversing speed 3.3 m/s

Torsional stress $\pm 180^\circ/\text{m}$

Ambient temperature range (stationary) $-40^\circ\text{C} \dots +80^\circ\text{C}$

Ambient temperature range (In motion) $-30^\circ\text{C} \dots +90^\circ\text{C}$

Ambient temperature during drag chain operation $-25^\circ\text{C} \dots +60^\circ\text{C}$

Mounting screw Brass, CuZn, nickel-plated