

# VC9S22-T80E-5/TEL

## Valve connector CI type – Connection Cable

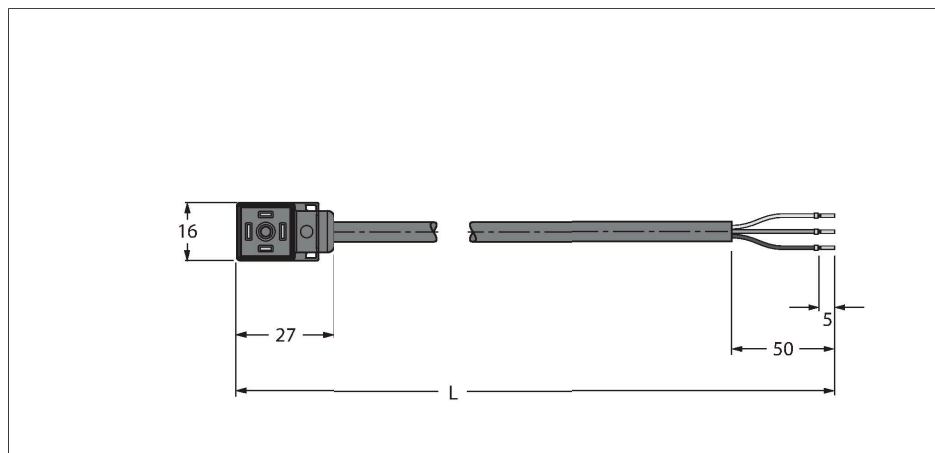

### Features



- 2-pin + PE, bridged
- Design according to the DIN EN 175301-803
- RoHS-compliant
- Protection class: IP65, IP67, IP68
- Protective component: Z-diode
- Sheath material: PVC
- Sheath color: black
- Resistant to chemicals and oils
- Flame retardant
- Resistant to acids and alkaline solutions
- Resistant to microbes and hydrolysis
- LABS-free
- Cable length: 5.0 m

### Contact assignment



### Circuit Diagram

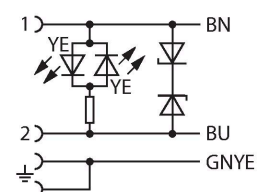

### Technical data

Type	VC9S22-T80E-5/TEL
ID	6606928
Connector A	Valve connector, Design CI
Number of Pins	2+PE, PE bridged
Contacts	Metal, CuSn, Silver-plated
Contact carriers	Plastic, PA, Black
Connector body	Plastic, TPU, Black/Translucent
Protective component	Z diode
Seal	Plastic, TPU
Display switch state	LED, Yellow/Yellow
Mechanical lifespan	> 100 Mating cycles
Pollution degree	3
Protection class	IP65, IP67, IP68, (mounted)
Cable diameter	Ø 6.1 mm ±0.20
Cable length	5 m
Cable jacket	PVC, Black
Core insulation	PVC
Core cross-section	3 x 0.75 mm <sup>2</sup>
Arrangement of strands	24 x 0.195 mm
Core colors	BN, BU, GNYE
<b>Electrical properties at +20 °C</b>	
Rated voltage	24 V
Test voltage	2000 V
Current	4 A
Insulation resistance	> 1 MΩ/km
Insulation resistance	≥ 10 <sup>8</sup> Ω
forward resistance	max. 57 Ω/km

## Technical data

### Mechanical and chemical properties

Bending radius (stationary installation)	$\geq 5 \times \varnothing$
Bending radius (flexible use)	$\geq 10 \times \varnothing$
Ambient temperature range (stationary)	-40 °C...+105 °C
Ambient temperature range (In motion)	0 °C...+80 °C
Mounting screw	Brass, CuZn, nickel-plated