

# TB-8M12-5-2/TXL

## Passive Actuator/Sensor Box, M12 x 1 – With Homerun Cable, 8-port

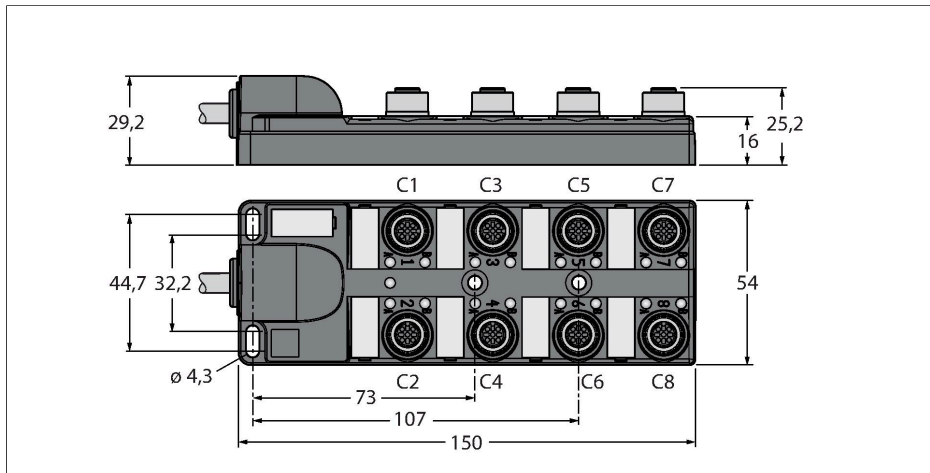

### Technical data

Type	TB-8M12-5-2/TXL
ID no.	6611947
Distributed I/O	8, with integral homerun cable
Housing	Plastic, PA, Black
I/O port	M12 x 1
Number of Pins	4+PE
Contacts	Brass, CuZn, Gold-plated
Contact carriers	Plastic, PA, Black
Seal	Plastic, FPM/FKM
Mechanical lifespan	> 100 Mating cycles
Group terminal	Cable
Cable diameter	Ø 10.39 mm
Cable length	2 m
Cable jacket	PUR, Black
Core insulation	PVC
Core cross-section	16 x 0.32 mm <sup>2</sup>
Cable conductor cross-section	3x 0.82 mm <sup>2</sup>
Core colors	VT, RD, GY, GN, BK, WH, PK, YE, RD-BU, GYPK, WHGN, WHYE, WHGY, YE BN, BNGN, GYBN
Core colors	BN, BU, GNYE
Electrical properties at +20 °C	
Rated voltage	30 V
Current	2 A per signal contact, total current 6 A
Insulation resistance	≥ 10 <sup>8</sup> Ω
forward resistance	≤ 5 mΩ

### Features



- Housing material: Nylon
- Housing color: black
- Protection class IP67
- RoHS-compliant
- CE compliant
- I/O port (number of pins): 4-pin + PE

### Contact assignment

I/O Connector



### Circuit Diagram

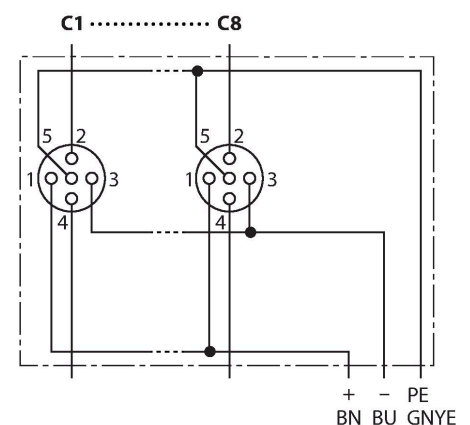

## Technical data

### Mechanical and chemical properties

Bending radius (stationary installation)	≥ 5 x Ø
Bending radius (flexible use)	≥ 15 x Ø
Ambient temperature range (stationary)	-40 °C...+85 °C

### Wiring

Port/Pin	C1/2	C1/4	C2/2	C2/4	C3/2	C3/4	C4/2	C4/4
M23 flange	7	15	4	5	8	16	14	3
Cable	GYPK	WH	RDBU	GN	WHGN	YE	BNGN	GY

Port/Pin	C5/2	C5/4	C6/2	C6/4	C7/2	C7/4	C8/2	C8/4
M23 flange	9	17	13	2	10	11	18	1
Cable	WHYE	PK	YEBN	RD	WHGY	BK	GYBN	VT

Power C1-C8	24V	0V	PE
M23 flange	19	6	12
Cable	BN	BU	GNYE

### Scope of delivery

Device	Quantity	Description
Junction boxes	1	Passive actuator/sensor junction box
VS-M12-BK	2	Closure caps for M12 female connectors
KS9/20	9	Labels

### Accessories

Ident-No.	Designation	Description
6900196	CK19-0	Field-wireable female M23, 19-pin, straight
6930225	CS19-0	Field-wireable male M23, 19-pin, straight
6625616	RKC5T-2-RSC5T/ TXL	Actuator/sensor cable, female M12 - male M12, straight, 5-pin, 2 m *
6936055	VS-M12-BK	Closure caps for M12 female connectors
8015002	KS9/20	Labels

\* Other lengths available on request